



**GENERAL
OPTICS**
Special Optics Solutions

INNOBIZ
기술혁신형중소기업

SBC
벤처기업

ANAB
ACCREDITED
ISO/IEC 17025
MANAGEMENT SYSTEMS
CERTIFICATION BODY

OR
ISO 9001:2015
ISO 14001:2015
CERTIFIED

F-theta Lens Catalog

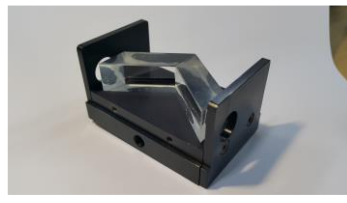

TEL : 82-32-684-9606
FAX : 82-32-684-9608
EMAIL : sales@generaloptics.co.kr
WEB : <https://generaloptics.co.kr>

General Optics Co., Ltd.

F-theta Lens Selection Guide

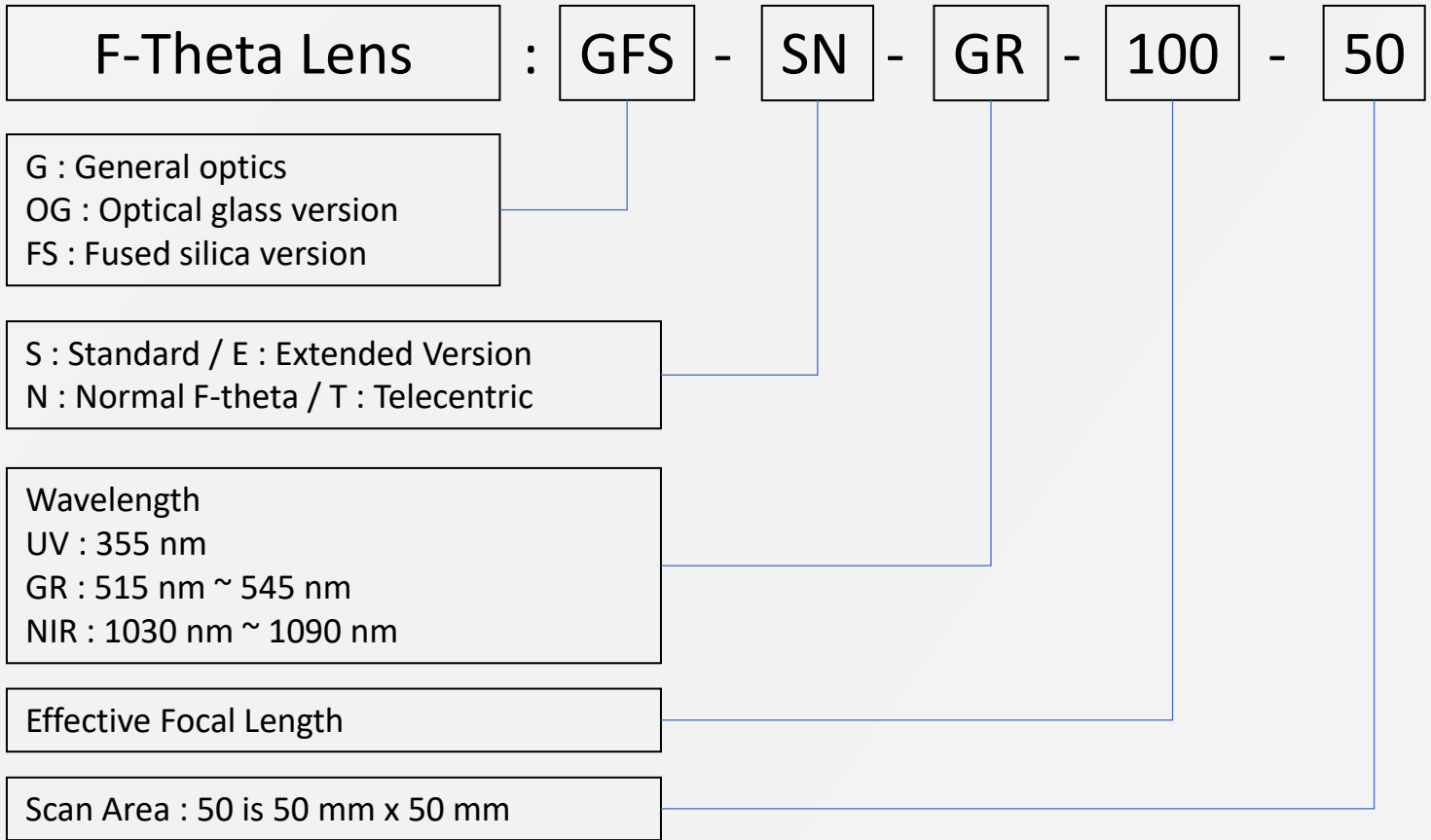

- Extended version was developed by the needs of the customers.

Mount Selection

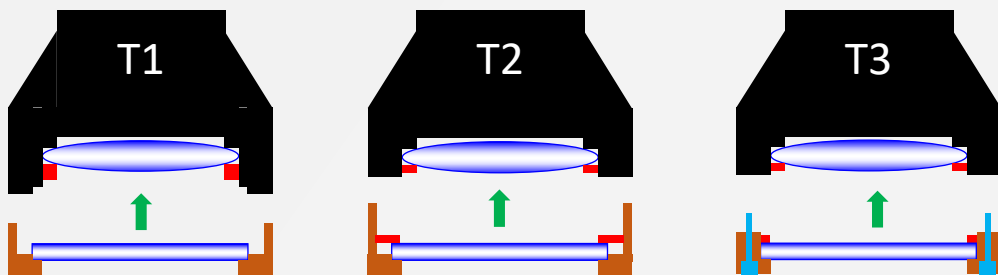

Type	Feature
T1	<ul style="list-style-type: none"> - Minimized product size. - No need retainer wrench. - Do not turn the window housing over, as the window can fall freely.
T2	<ul style="list-style-type: none"> - The most popular type. - Improved safety by mounted window to the window housing.
T3	<ul style="list-style-type: none"> - Easy separation of window housing using bolts. - Bigger product size.

UV Product list

Model name	Max. Input beam diameter	Working distance	Page number
GFS-ST-UV-55-15	10.0 mm \emptyset	59.67 mm	4 page
GFS-ST-UV-109-63	6.0 mm \emptyset	140.16 mm	5 page
GFS-ST-UV-135-75	10.0 mm \emptyset	187.20 mm	6 page
GFS-ST-UV-163-90	10.0 mm \emptyset	219.79 mm	7 page

Green Product list

Model name	Max. Input beam diameter	Working distance	Page number
GFS-ST-GR-160-55	30.0 mm \emptyset	216.72 mm	8 page
GFS-ST-GR-254-100	30.0 mm \emptyset	334.67 mm	9 page

NIR Product list

Model name	Max. Input beam diameter	Working distance	Page number
Optical glass model			
GOG-SN-NIR-160-106	12.0 mm \emptyset	175.72 mm	10 page
GOG-SN-NIR-254-180	17.2 mm \emptyset	290.00 mm	11 page
GOG-SN-NIR-420-300	20.0 mm \emptyset	465.53 mm	12 page
Fused silica model			
GFS-ST-NIR-160-75	20.0 mm \emptyset	209.52 mm	13 page
GFS-ET-NIR-254-40	12.0 mm \emptyset	255.42 mm	14 page
GFS-ET-NIR-254-85	20.0 mm \emptyset	320.42 mm	15 page
GFS-ST-NIR-254-120	20.0 mm \emptyset	330.62 mm	16 page
GFS-ST-NIR-254-160	20.0 mm \emptyset	328.73 mm	17 page
GFS-ST-NIR-330-165	30.0 mm \emptyset	418.05 mm	18 page
GFS-ET-NIR-340-40	15.0 mm \emptyset	281.08 mm	19 page
GFS-SN-NIR-340-200	20.0 mm \emptyset	417.38 mm	20 page
GFS-SN-NIR-420-220	20.0 mm \emptyset	511.45 mm	21 page

GFS-ST-UV-55-15

Specifications	GFS-ST-UV-55-15
Design wavelength	355 nm
Effective focal length	55.0 mm
Max. Input beam diameter	10 mm \emptyset
Diagonal Scan angle	$\pm 11.3^\circ$
Scan field	15 mm x 15 mm
A1(1 st mirror to 2 nd mirror distance)	13.00 mm
A2(2 nd mirror to Flange)	37.51 mm
Working distance	59.67 mm
Telecentricity	$< 1.5^\circ$
Flange-Focus	93.06 mm
Lens diameter	90.00 mm \emptyset
Lens length	55.80 mm
Mount	M85X1.0
Window	Mounted(W2-PW-49.0-3.0-UV-355-0)
Weight	T2 : 0.7 kg

- Zemax Blackbox file is available.

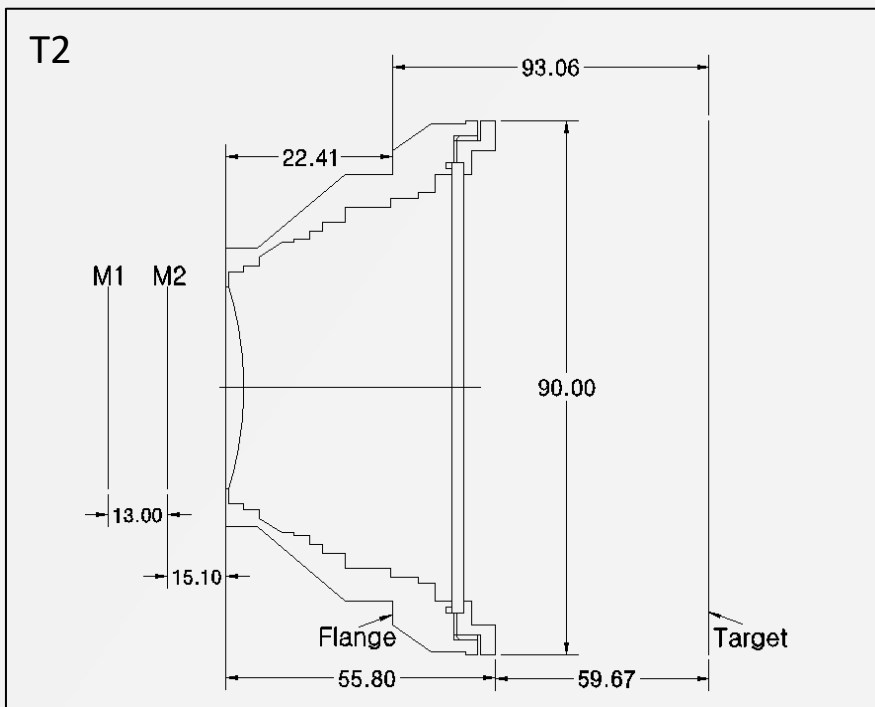

- Layout is different from actual product, please refer to dimension only.
 - Focal length tolerance : $\pm 1.5\%$

GFS-ST-UV-109-63

Specifications	GFS-ST-UV-109-63
Design wavelength	355 nm
Effective focal length	109.0 mm
Max. Input beam diameter	6 mm \varnothing
Diagonal Scan angle	$\pm 25.2^\circ$
Scan field	63 mm x 63 mm
A1(1 st mirror to 2 nd mirror distance)	12.56 mm
A2(2 nd mirror to Flange)	37.51 mm
Working distance	140.16 mm
Telecentricity	$< 1.5^\circ$
Flange-Focus	218.92 mm
Lens diameter	124.00 mm \varnothing
Lens length	98.26 mm
Mount	M85X1.0
Window	Mounted(W2-PW-109.0-3.0-UV-355-0)
Weight	T2 : 1.6 kg

- Zemax Blackbox file is available.

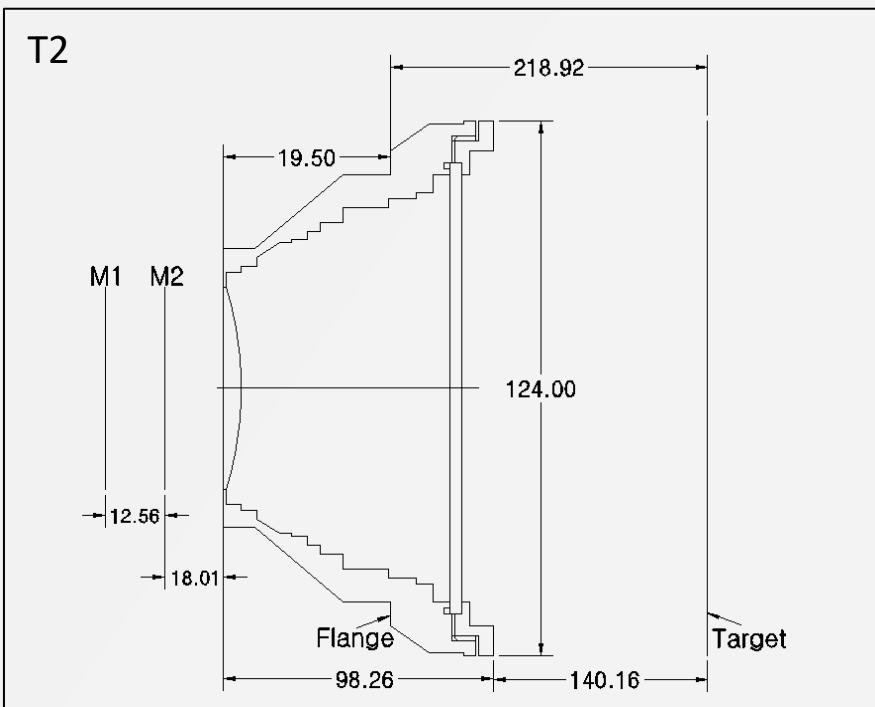

- Layout is different from actual product, please refer to dimension only.
 - Focal length tolerance : $\pm 1.5\%$

GFS-ST-UV-135-75

Specifications	GFS-ST-UV-135-75
Design wavelength	355 nm
Effective focal length	135.0 mm
Max. Input beam diameter	10 mm \emptyset
Diagonal Scan angle	$\pm 24.0^\circ$
Scan field	75 mm x 75 mm
A1(1 st mirror to 2 nd mirror distance)	12.56 mm
A2(2 nd mirror to Flange)	40.80 mm
Working distance	187.20 mm
Telecentricity	$< 1.2^\circ$
Flange-Focus	280.14 mm
Lens diameter	148.00 mm \emptyset
Lens length	111.14 mm
Mount	M85X1.0
Window	Mounted(W2-PW-133.0-3.0-UV-355-0)
Weight	T2 : 2.4 kg

- Zemax Blackbox file is available.

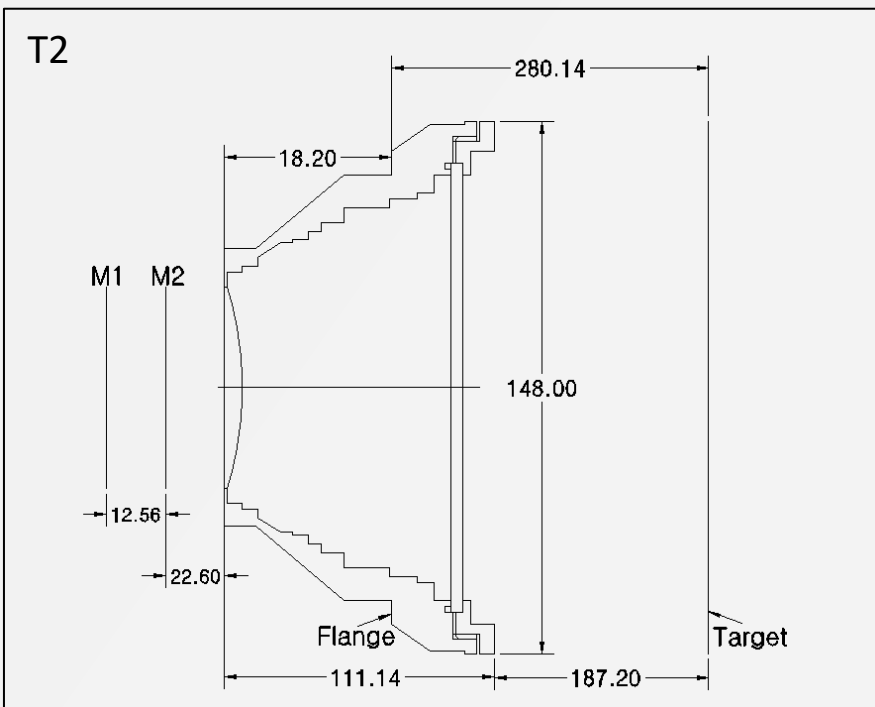

- Layout is different from actual product, please refer to dimension only.
 - Focal length tolerance : $\pm 1.5\%$

GFS-ST-UV-163-90

Specifications	GFS-ST-UV-163-90
Design wavelength	355 nm
Effective focal length	163.4 mm
Max. Input beam diameter	10 mm \varnothing
Diagonal Scan angle	$\pm 24.1^\circ$
Scan field	90 mm x 90 mm
A1(1 st mirror to 2 nd mirror distance)	16.42 mm
A2(2 nd mirror to Flange)	39.70 mm
Working distance	219.79 mm
Telecentricity	$< 3.5^\circ$
Flange-Focus	314.24 mm
Lens diameter	145.00 mm \varnothing
Lens length	113.42 mm
Mount	M85X1.0
Window	Mounted(W2-PW-133.0-3.0-UV-355-0)
Weight	T2 : 2.3 kg / T3 : 2.7 kg

- Zemax Blackbox file is available.

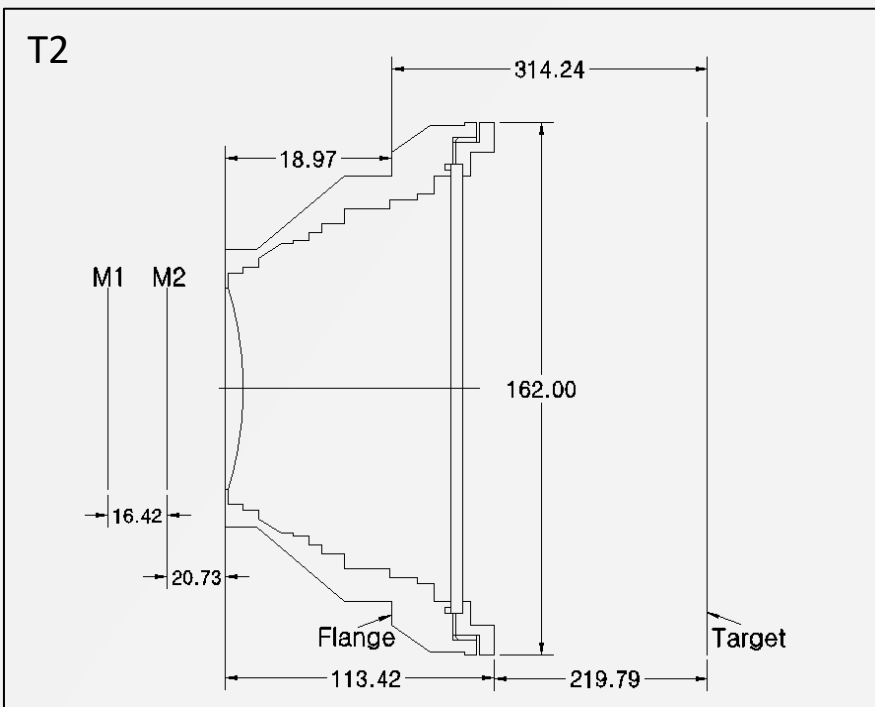

- Layout is different from actual product, please refer to dimension only.
 - Focal length tolerance : $\pm 1.5\%$

GFS-ST-GR-160-55

Specifications	GFS-ST-GR-160-55
Design wavelength	515 nm
Effective focal length	160.0 mm
Max. Input beam diameter	30 mm \varnothing
Diagonal Scan angle	$\pm 14.5^\circ$
Scan field	55 mm x 55 mm
A1(1 st mirror to 2 nd mirror distance)	35.53 mm
A2(2 nd mirror to Flange)	35.18 mm
Working distance	216.72 mm
Telecentricity	$< 1.8^\circ$
Flange-Focus	347.54 mm
Lens diameter	162.00 mm \varnothing
Lens length	138.82 mm
Mount	M85X1.0
Window	Mounted(W2-PW-149.0-3.0-UV-515-0)
Weight	T2 : 3.3 kg

- Zemax Blackbox file is available.

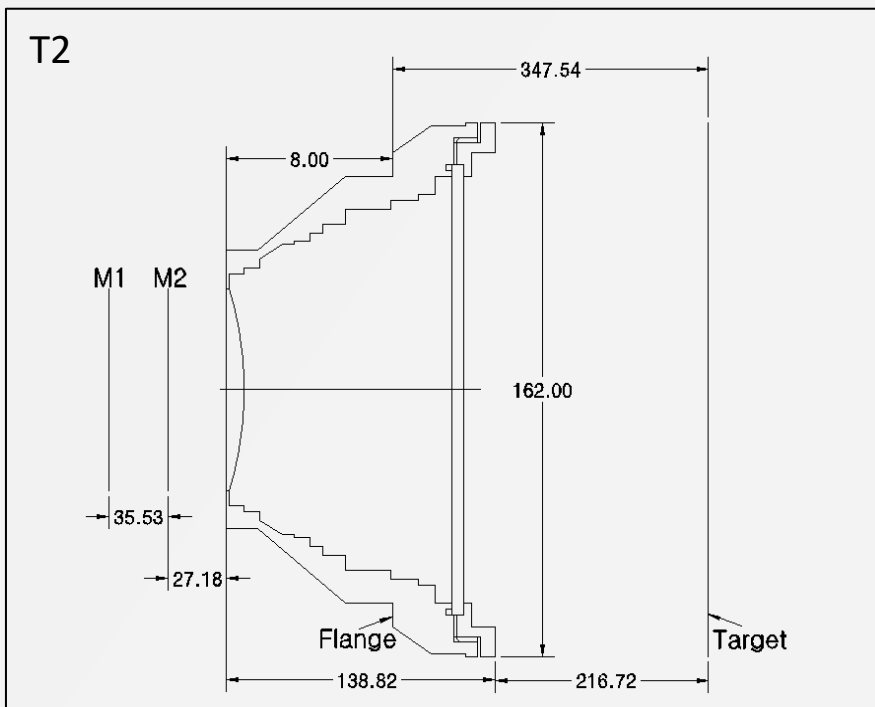

- Layout is different from actual product, please refer to dimension only.
 - Focal length tolerance : $\pm 1.5\%$

GFS-ST-GR-254-100

Specifications	GFS-ST-GR-254-100
Design wavelength	515 nm
Effective focal length	254.0 mm
Max. Input beam diameter	30 mm \varnothing
Diagonal Scan angle	$\pm 16.4^\circ$
Scan field	100 mm x 100 mm
A1(1 st mirror to 2 nd mirror distance)	35.53 mm
A2(2 nd mirror to Flange)	34.38 mm
Working distance	334.67 mm
Telecentricity	$< 5.0^\circ$
Flange-Focus	440.29 mm
Lens diameter	156.00 mm \varnothing
Lens length	113.62 mm
Mount	M85X1.0
Window	Mounted(W2-PW-143.0-3.0-UV-515-0)
Weight	T2 : 2.7 kg

- Zemax Blackbox file is available.

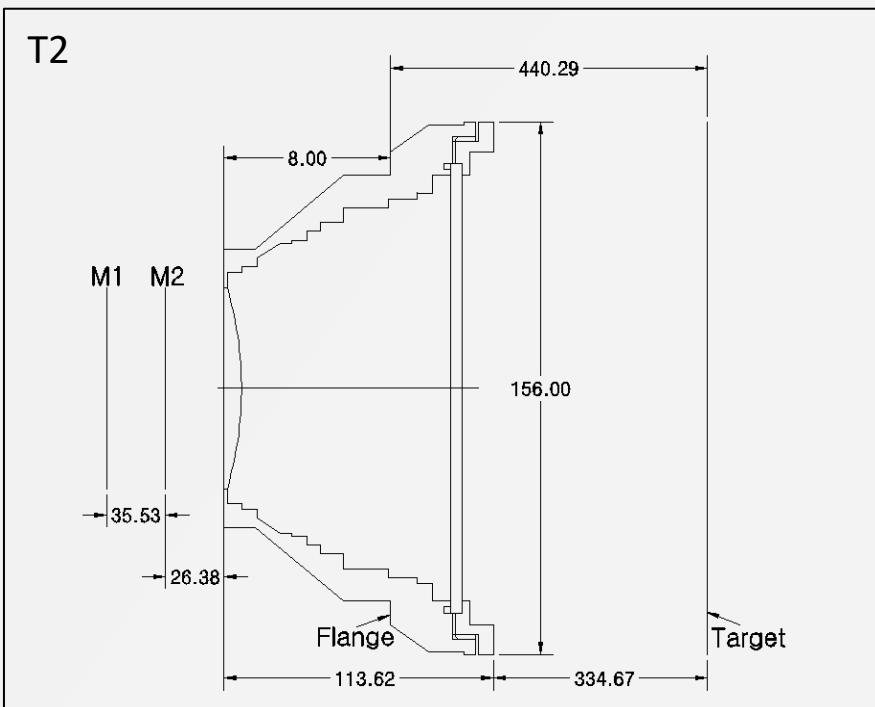

- Layout is different from actual product, please refer to dimension only.
 - Focal length tolerance : $\pm 1.5\%$

GOG-SN-NIR-160-106

Specifications	GOG-SN-NIR-160-106
Design wavelength	1064 nm
Effective focal length	160 mm
Max. Input beam diameter	12 mm \varnothing
Diagonal Scan angle	$\pm 26.8^\circ$
Scan field	106 mm x 106 mm
A1(1 st mirror to 2 nd mirror distance)	16 mm
A2(2 nd mirror to Flange)	49.84 mm
Working distance	175.72 mm
Telecentricity	$< 15.5^\circ$
Flange-Focus	184.22 mm
Lens diameter	89.00 mm \varnothing
Lens length	52.26 mm
Mount	M85X1.0
Window	Mounted(W2-PW-76.0-2.0-C-1064-0)
Weight	T1 : 0.5 kg

- Zemax Blackbox file is available.

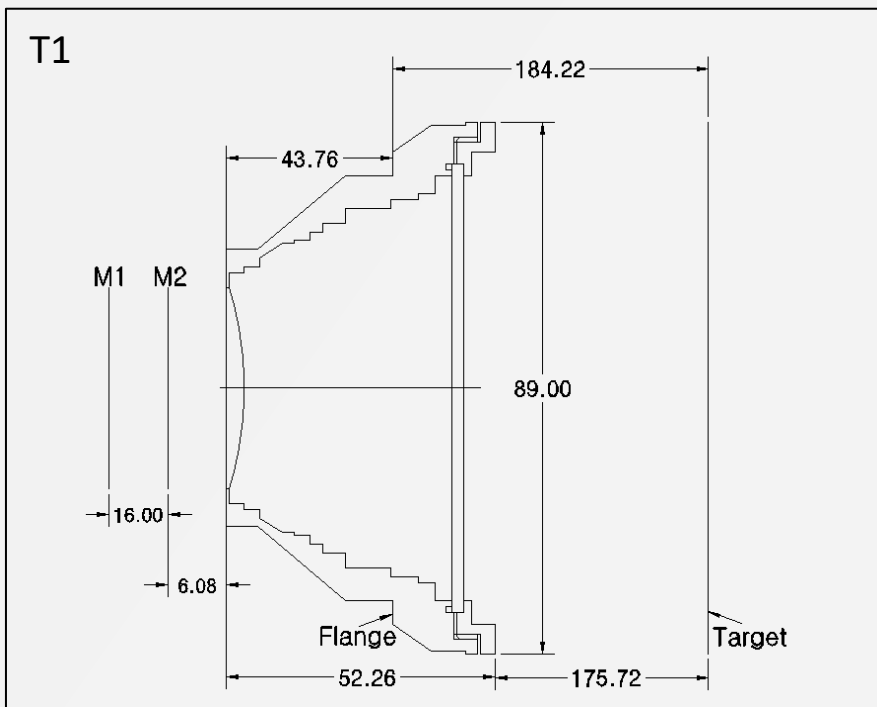

- Layout is different from actual product, please refer to dimension only.
 - Focal length tolerance : $\pm 1.5\%$

GOG-SN-NIR-254-180

Specifications	GOG-SN-NIR-254-180
Design wavelength	1064 nm
Effective focal length	254 mm
Max. Input beam diameter	17.2 mm \varnothing
Diagonal Scan angle	$\pm 29.7^\circ$
Scan field	180 mm x 180 mm
A1(1 st mirror to 2 nd mirror distance)	16.60 mm
A2(2 nd mirror to Flange)	29.77 mm
Working distance	289.90 mm
Telecentricity	$< 18.0^\circ$
Flange-Focus	341.04 mm
Lens diameter	128.00 mm \varnothing
Lens length	71.64 mm
Mount	M85X1.0
Window	Mounted(W2-PW-121.0-3.0-C-1064-0)
Weight	T1 : 1.2 kg

- Zemax Blackbox file is available.

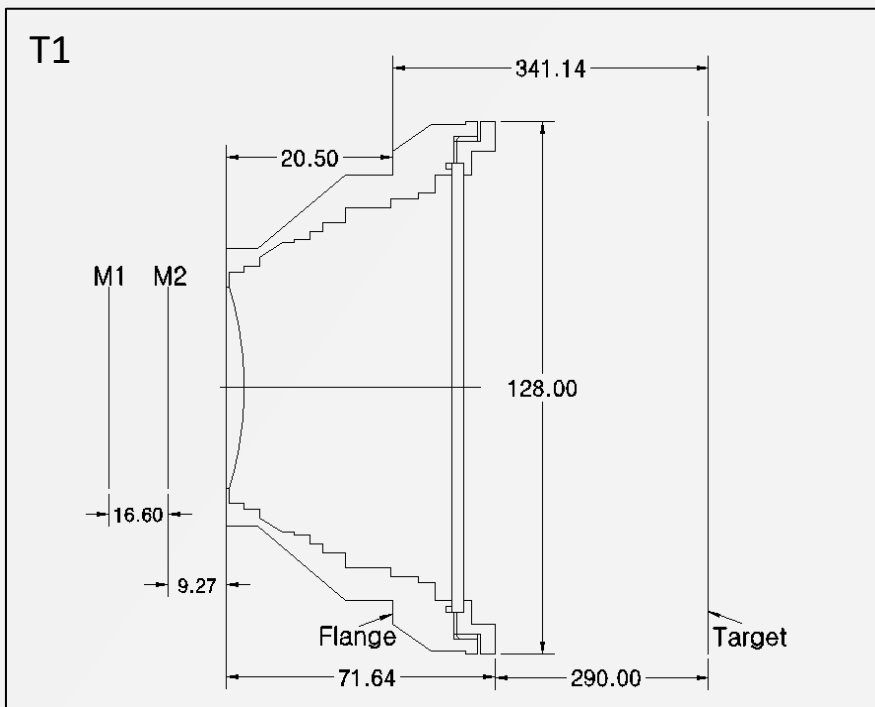

- Layout is different from actual product, please refer to dimension only.
 - Focal length tolerance : $\pm 1.5\%$

GOG-SN-NIR-420-300

Specifications	GOG-SN-NIR-420-300
Design wavelength	980 nm
Effective focal length	420 mm
Max. Input beam diameter	20.0 mm \emptyset
Diagonal Scan angle	$\pm 29.7^\circ$
Scan field	300 mm x 300 mm
A1(1 st mirror to 2 nd mirror distance)	25.60 mm
A2(2 nd mirror to Flange)	23.00 mm
Working distance	465.55 mm
Telecentricity	$< 19.0^\circ$
Flange-Focus	563.02 mm
Lens diameter	170.00 mm \emptyset
Lens length	109.42 mm
Mount	M85X1.0
Window	Mounted(W2-PW-158.0-3.0-C-1064-0)
Weight	T1 : 3.5 kg

- Zemax Blackbox file is available.

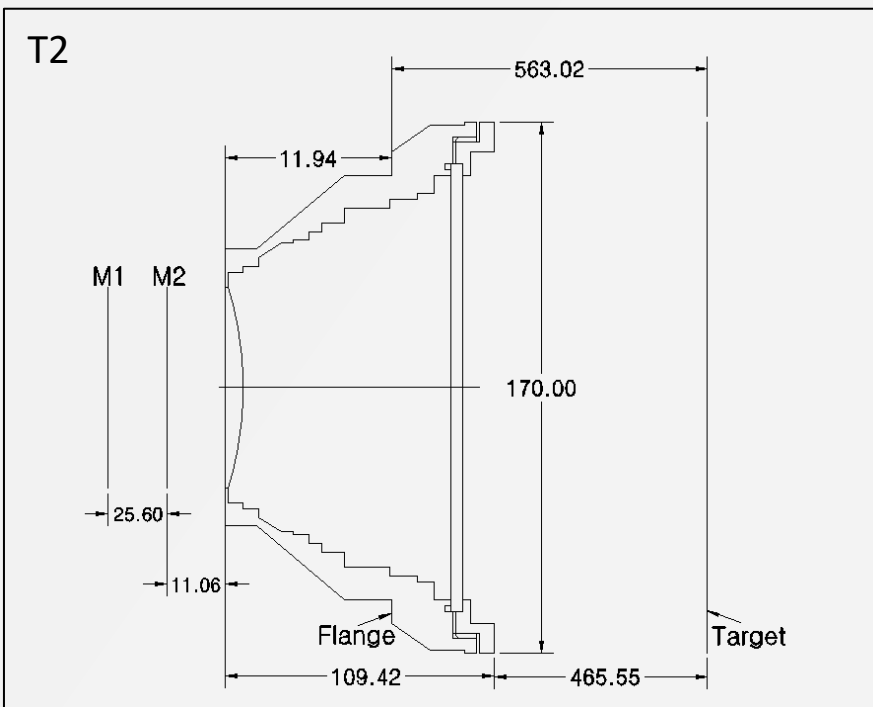

- Layout is different from actual product, please refer to dimension only.
 - Focal length tolerance : $\pm 1.5\%$

GFS-ST-NIR-160-75

Specifications	GFS-ST-NIR-160-75
Design wavelength	1064 nm
Effective focal length	160 mm
Max. Input beam diameter	20.0 mm \emptyset
Diagonal Scan angle	$\pm 20.1^\circ$
Scan field	75 mm x 75 mm
A1(1 st mirror to 2 nd mirror distance)	26.6 mm
A2(2 nd mirror to Flange)	32.36 mm
Working distance	209.52 mm
Telecentricity	$< 3.1^\circ$
Flange-Focus	309.06 mm
Lens diameter	151.00 mm \emptyset
Lens length	109.13 mm
Mount	M85X1.0
Window	Mounted(T1 : W2-PW-128.0-3.0-UV-1064-0) Mounted(T3 : W2-PW-124.0-3.0-UV-1064-0)
Weight	T1 : 2.2 kg / T3 : 2.3 kg

- Zemax Blackbox file is available.

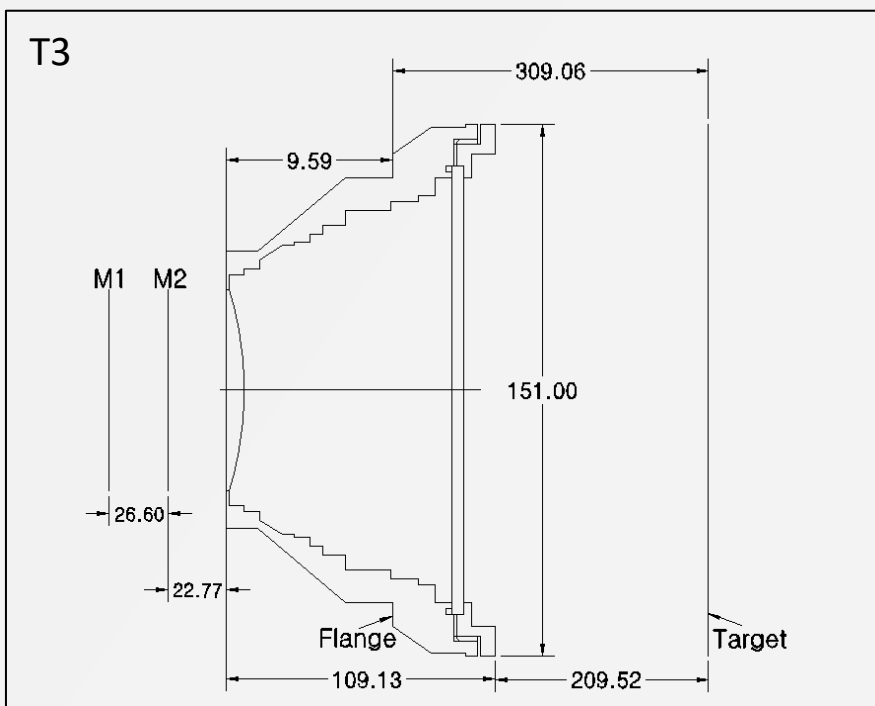

- Layout is different from actual product, please refer to dimension only.
- Focal length tolerance : $\pm 1.5\%$

GFS-ET-NIR-254-40

Specifications	GFS-ET-NIR-254-40
Design wavelength	1064 nm
Effective focal length	254 mm
Max. Input beam diameter	12.0 mm \varnothing
Diagonal Scan angle	$\pm 4.8^\circ$
Scan field	40 mm x 40 mm
A1(1 st mirror to 2 nd mirror distance)	27.0 mm
A2(2 nd mirror to Flange)	54.19 mm
Working distance	255.42 mm
Telecentricity	$< 4.5^\circ$
Flange-Focus	275.52 mm
Lens diameter	57.00 mm \varnothing
Lens length	33.79 mm
Mount	M55X1.0
Window	Mounted(W2-PW-45.0-3.0-UV-1064-0)
Weight	T1 : 0.15 kg

- Zemax Blackbox file is available.

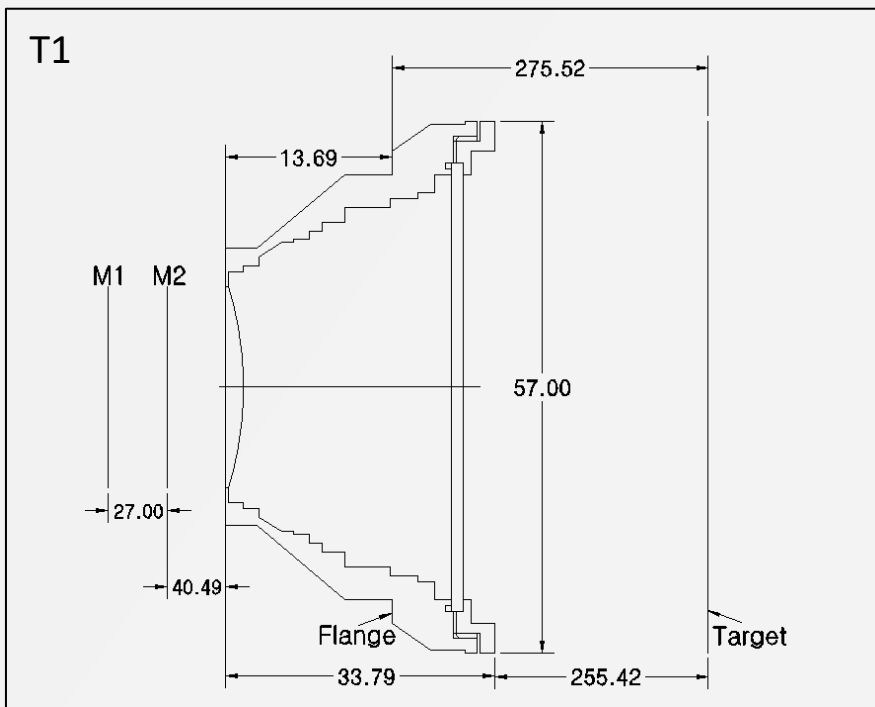

- Layout is different from actual product, please refer to dimension only.
 - Focal length tolerance : $\pm 1.5\%$

GFS-ET-NIR-254-85

Specifications	GFS-ET-NIR-254-85
Design wavelength	1064 nm
Effective focal length	254.0 mm
Max. Input beam diameter	20.0 mm \varnothing
Diagonal Scan angle	$\pm 13.9^\circ$
Scan field	85 mm x 85 mm
A1(1 st mirror to 2 nd mirror distance)	26.6 mm
A2(2 nd mirror to Flange)	34.94 mm
Working distance	320.42 mm
Telecentricity	$< 6.0^\circ$
Flange-Focus	386.83 mm
Lens diameter	117.00 mm \varnothing
Lens length	76.35 mm
Mount	M85X1.0
Window	Mounted(W2-PW-90.0-3.0-UV-1064-0)
Weight	T3 : 1.0 kg

- Zemax Blackbox file is available.

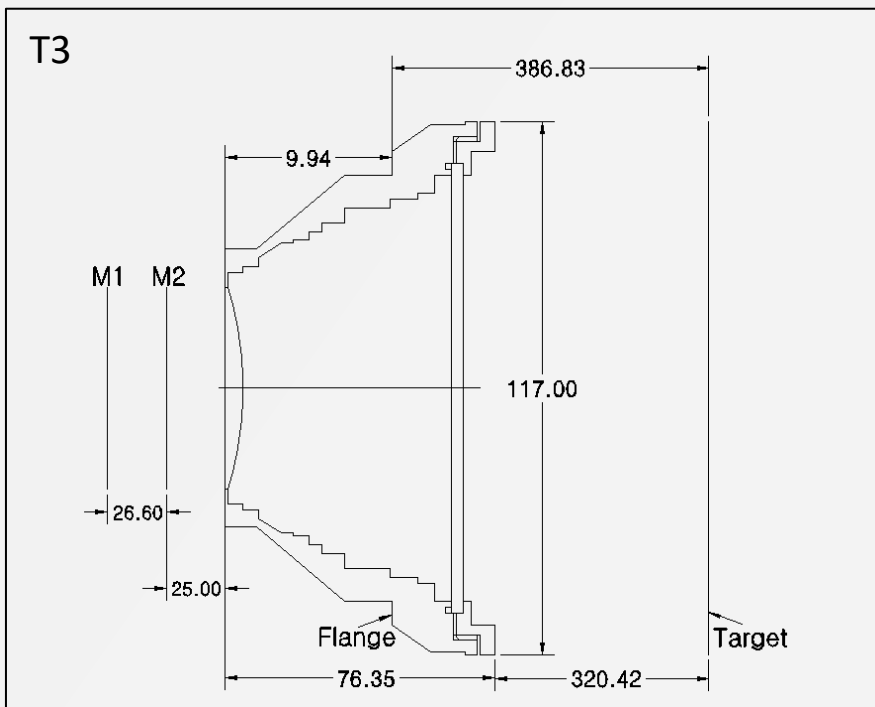

- Layout is different from actual product, please refer to dimension only.
 - Focal length tolerance : $\pm 1.5\%$

GFS-ST-NIR-254-120

Specifications	GFS-ST-NIR-254-120
Design wavelength	1064 nm
Effective focal length	254 mm
Max. Input beam diameter	20.0 mm \varnothing
Diagonal Scan angle	$\pm 20.1^\circ$
Scan field	120 mm x 120 mm
A1(1 st mirror to 2 nd mirror distance)	26.6 mm
A2(2 nd mirror to Flange)	45.40 mm
Working distance	330.62 mm
Telecentricity	$< 6.5^\circ$
Flange-Focus	422.60 mm
Lens diameter	162.00 mm \varnothing
Lens length	109.76 mm
Mount	M85X1.0
Window	Mounted(T1 : W2-PW-139.0-3.0-UV-1064-0) Mounted(T3 : W2-PW-135.0-3.0-UV-1064-0)
Weight	T1 : 2.3 kg / T3 : 2.5 kg

- Zemax Blackbox file is available.

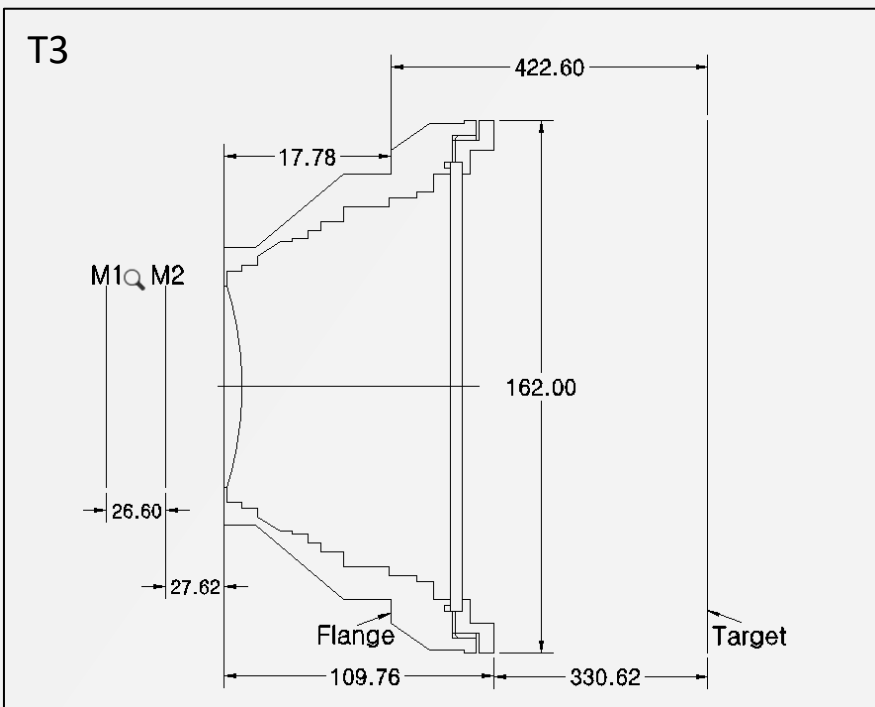

- Layout is different from actual product, please refer to dimension only.
- Focal length tolerance : $\pm 1.5\%$

GFS-ST-NIR-254-160

Specifications	GFS-ST-NIR-254-160
Design wavelength	1064 nm
Effective focal length	254 mm
Max. Input beam diameter	20.0 mm \emptyset
Diagonal Scan angle	$\pm 28.0^\circ$
Scan field	160 mm x 160 mm
A1(1 st mirror to 2 nd mirror distance)	25.8 mm
A2(2 nd mirror to Flange)	34.61 mm
Working distance	328.73 mm
Telecentricity	$< 8.5^\circ$
Flange-Focus	436.12 mm
Lens diameter	190.00 mm \emptyset
Lens length	120.14 mm
Mount	M85X1.0
Window	Mounted(W2-PW-179.0-3.0-UV-1064-0)
Weight	T2 : 4.2 kg

- Zemax Blackbox file is available.

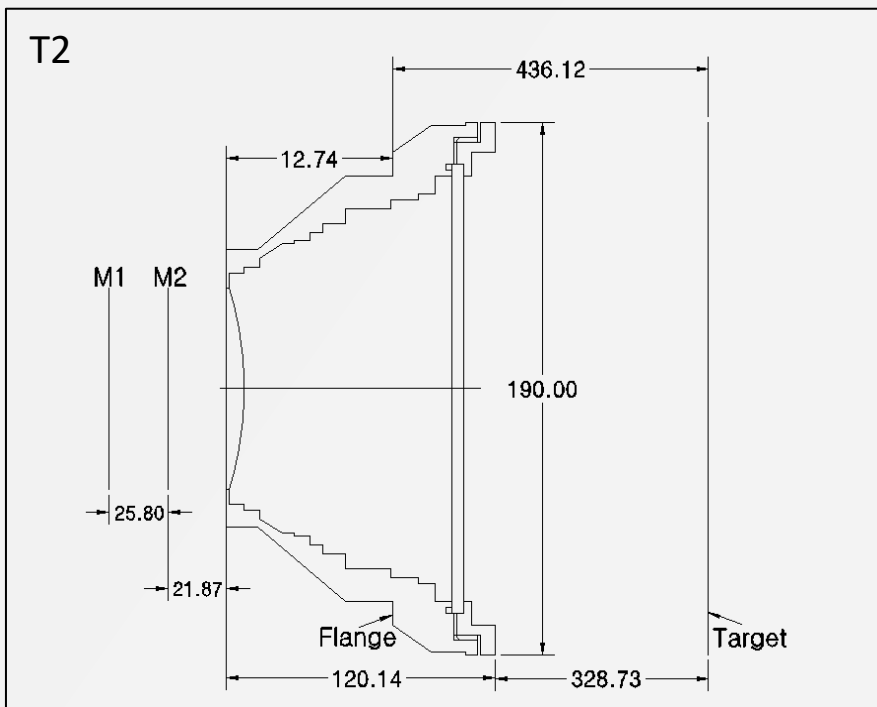

- Layout is different from actual product, please refer to dimension only.
 - Focal length tolerance : $\pm 1.5\%$

GFS-ST-NIR-330-165

Specifications	GFS-ST-NIR-330-165
Design wavelength	1064 nm
Effective focal length	330 mm
Max. Input beam diameter	30.0 mm \varnothing
Diagonal Scan angle	$\pm 21.3^\circ$
Scan field	165 mm x 165 mm
A1(1 st mirror to 2 nd mirror distance)	37.00 mm
A2(2 nd mirror to Flange)	33.95 mm
Working distance	418.05 mm
Telecentricity	$< 8.8^\circ$
Flange-Focus	522.50 mm
Lens diameter	190.00 mm \varnothing
Lens length	112.45 mm
Mount	M85X1.0
Window	Mounted(W2-PW-161.0-3.0-UV-1064-0)
Weight	T3 : 3.6 kg

- Zemax Blackbox file is available.

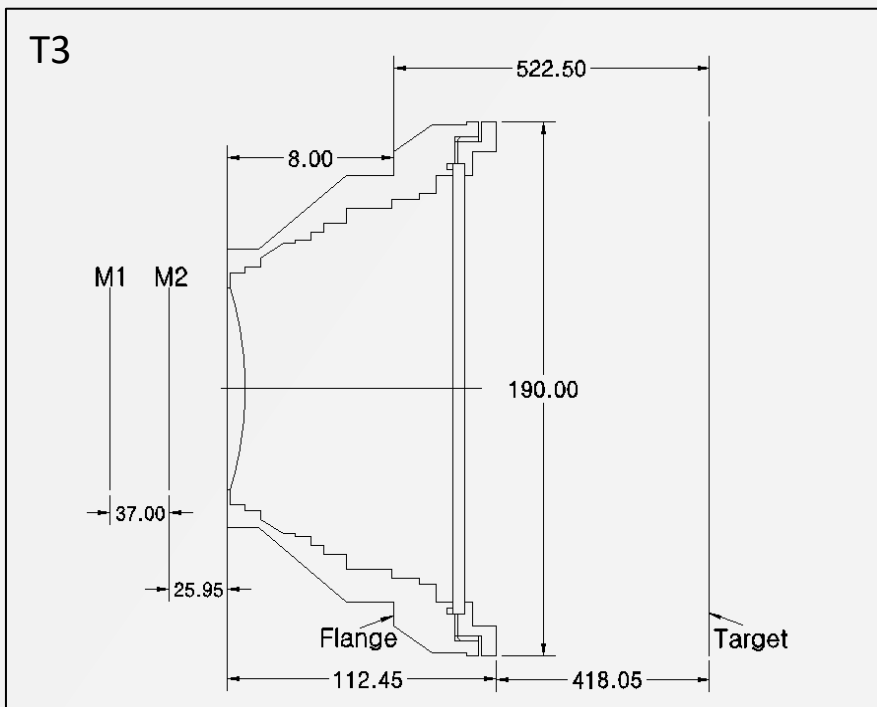

- Layout is different from actual product, please refer to dimension only.
 - Focal length tolerance : $\pm 1.5\%$

GFS-ET-NIR-340-40

Specifications	GFS-ET-NIR-340-40
Design wavelength	1064 nm
Effective focal length	340 mm
Max. Input beam diameter	15.0 mm \varnothing
Diagonal Scan angle	$\pm 4.8^\circ$
Scan field	40 mm x 40 mm
A1(1 st mirror to 2 nd mirror distance)	27.0 mm
A2(2 nd mirror to Flange)	52.19 mm
Working distance	281.08 mm
Telecentricity	$< 4.5^\circ$
Flange-Focus	316.38 mm
Lens diameter	57.00 mm \varnothing
Lens length	43.51 mm
Mount	M55X1.0
Window	Mounted(W2-PW-50.0-3.0-UV-1064-0)
Weight	T1 : 0.18 kg

- Zemax Blackbox file is available.

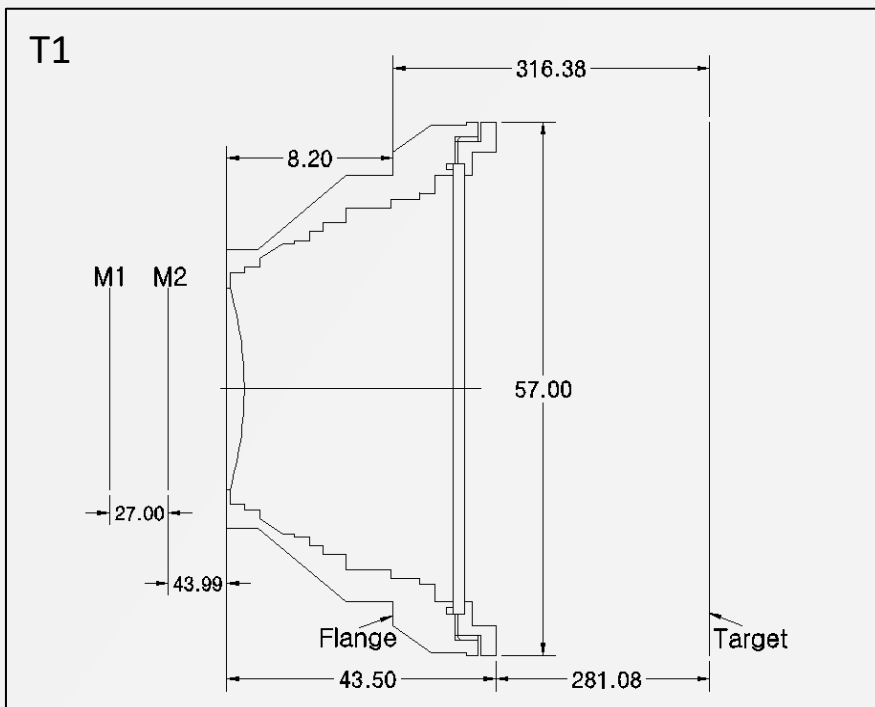

- Layout is different from actual product, please refer to dimension only.
 - Focal length tolerance : $\pm 1.5\%$

GFS-SN-NIR-340-200

Specifications	GFS-SN-NIR-340-200
Design wavelength	1064 nm
Effective focal length	340 mm
Max. Input beam diameter	20.0 mm \emptyset
Diagonal Scan angle	$\pm 25.2^\circ$
Scan field	200 mm x 200 mm
A1(1 st mirror to 2 nd mirror distance)	25.0 mm
A2(2 nd mirror to Flange)	23.41 mm
Working distance	417.38 mm
Telecentricity	$< 12.5^\circ$
Flange-Focus	513.47 mm
Lens diameter	158.00 mm \emptyset
Lens length	103.59 mm
Mount	M85X1.0
Window	Mounted(W2-PW-145.0-3.0-UV-1064-0)
Weight	T2 : 2.6 kg

- Zemax Blackbox file is available.

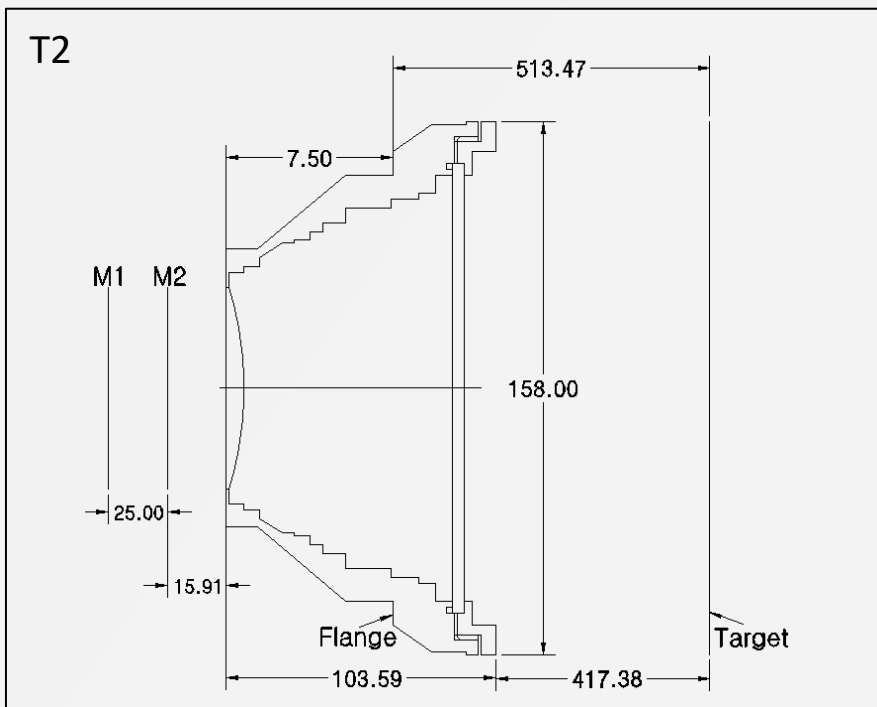

- Layout is different from actual product, please refer to dimension only.
 - Focal length tolerance : $\pm 1.5\%$

GFS-SN-NIR-420-220

Specifications	GFS-ST-NIR-420-220
Design wavelength	1064 nm
Effective focal length	420 mm
Max. Input beam diameter	20.0 mm \varnothing
Diagonal Scan angle	$\pm 22.0^\circ$
Scan field	220 mm x 220 mm
A1(1 st mirror to 2 nd mirror distance)	26.60 mm
A2(2 nd mirror to Flange)	33.66 mm
Working distance	511.45 mm
Telecentricity	$< 12.5^\circ$
Flange-Focus	586.47 mm
Lens diameter	157.00 mm \varnothing
Lens length	84.96 mm
Mount	M85X1.0
Window	Mounted(W2-PW-130.0-3.0-UV-1064-0)
Weight	T3 : 1.7 kg

- Zemax Blackbox file is available.

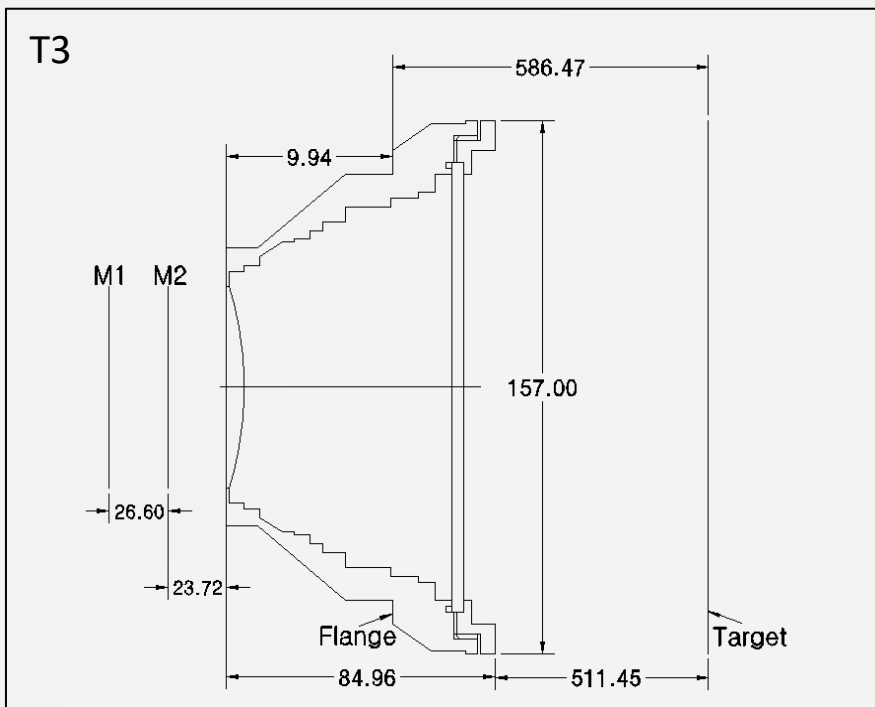

- Layout is different from actual product, please refer to dimension only.
 - Focal length tolerance : $\pm 1.5\%$



82, Anaji-ro, Gyeyang-gu, Incheon, 21107, Republic of Korea

TEL : 82-32-684-9606

FAX : 82-32-684-9608

EMAIL : sales@generaloptics.co.kr

WEB : <https://generaloptics.co.kr>